

Jewel Box Placemat

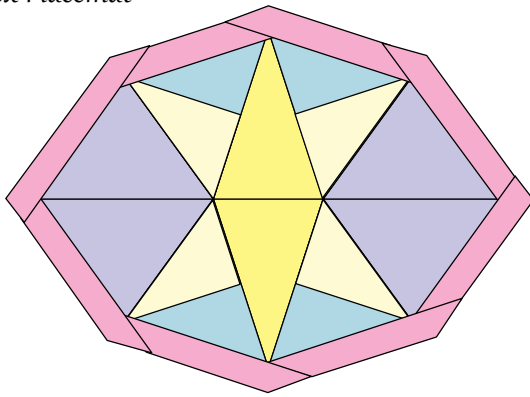

Fabric	One or Two Placemats	Four Placemats
A	Fat Quarter	1/4 yd
B	Fat Quarter	3/8 yd
C	Fat Quarter	1/4 yd
D	Fat Quarter	1/4 yd
E	Fat Quarter	3/8 yd
Backing	Fat Quarter per placemat	1 yd

Cutting The Jewel Box Placemat

Fabric	Single Placemat	Two Placemats	Four Placemats
A	One 7" x half width	One 7" x half width	One 7" x width
B	One 5" x half width	One 5" x width	Two 5" x width
C	One 4" x half width	One 4" x width	Two 4" x width
D	One 4" x half width	One 4" x width	Two 4" x width
E	Four 1 1/2" x half width	Four 1 1/2" x width	Eight 1 1/2" x width

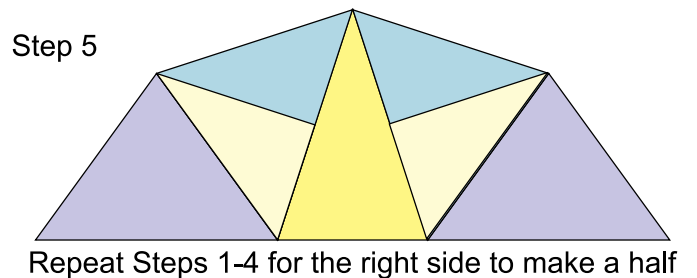
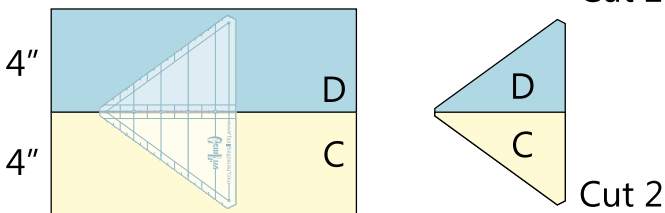
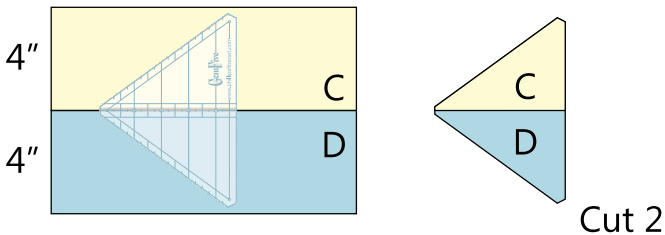
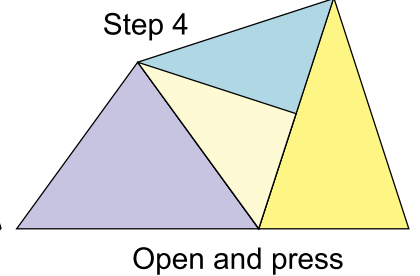
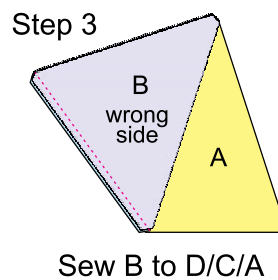
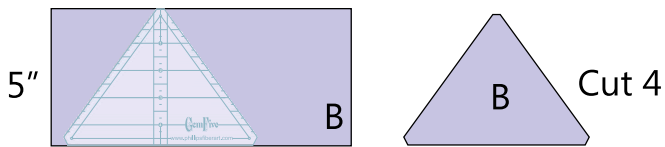
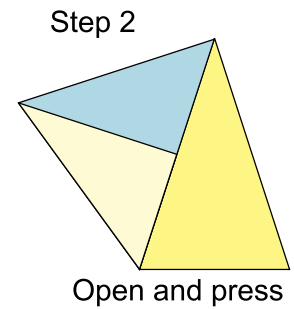
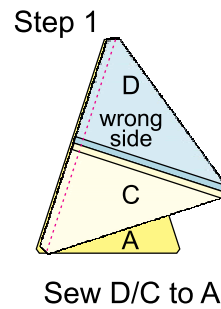
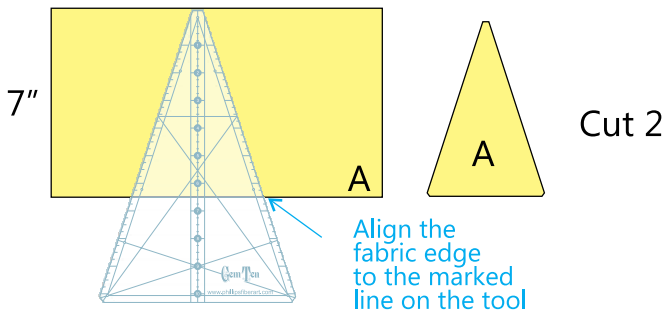
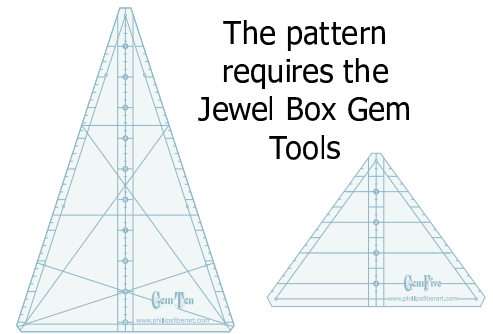

Jewel Box Placemat

Step 5

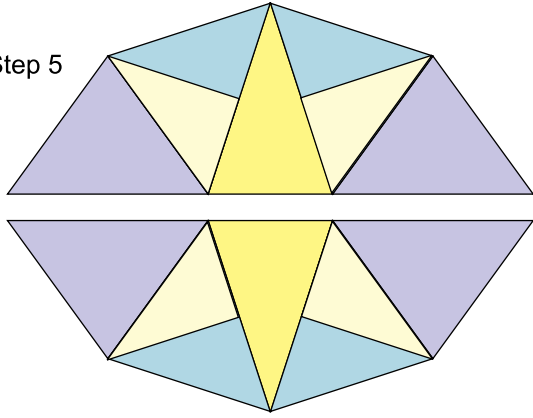

Sew the halves together

Step 7

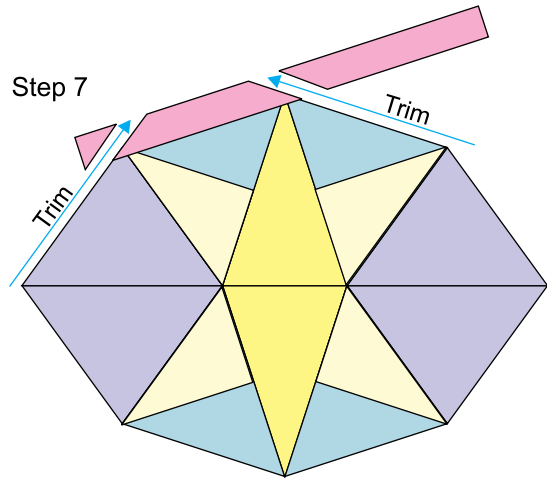

Trim the strips as shown

Step 8

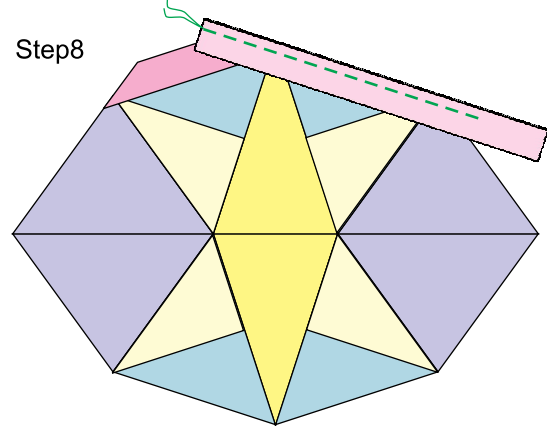

Add another border strip

Step 6

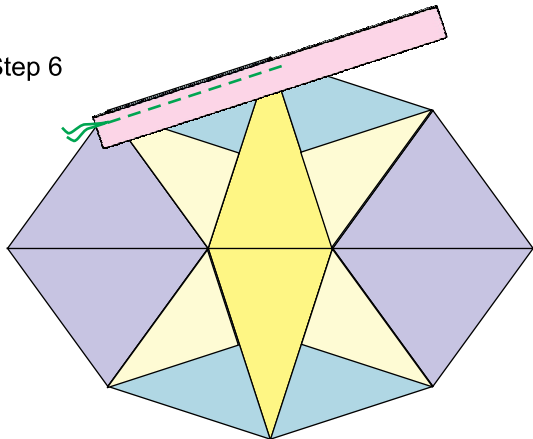

Sew a border strip to one side

Step 9

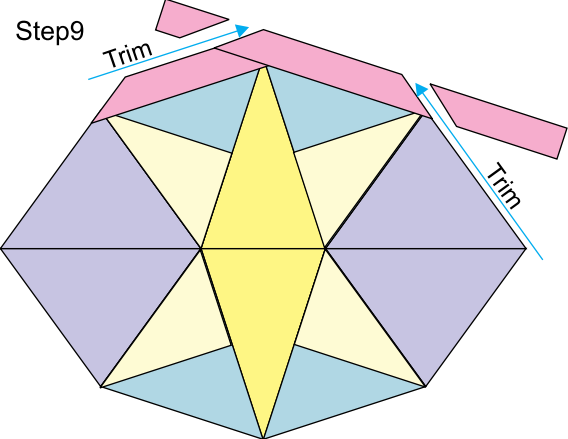

Trim the strips as shown

Step 10

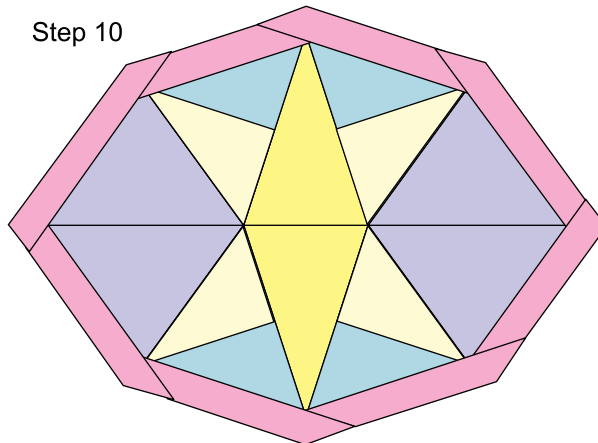

Continue adding and trimming strips until complete